

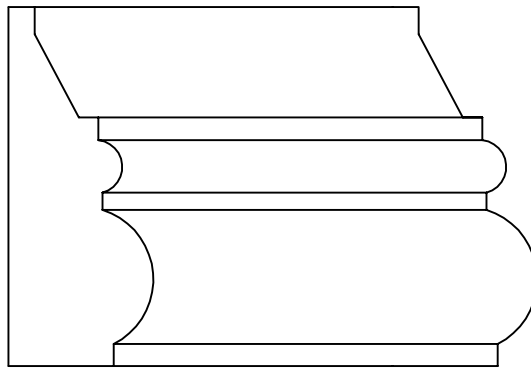

3/4"
x
1-7/8"



SAW 2252

SAW MOULDING (845)-336-8090

Full scale	Approved:	Drawn by GS
Date		Revised

SAW 2252

Drawing no. A-1