

SAW 6634

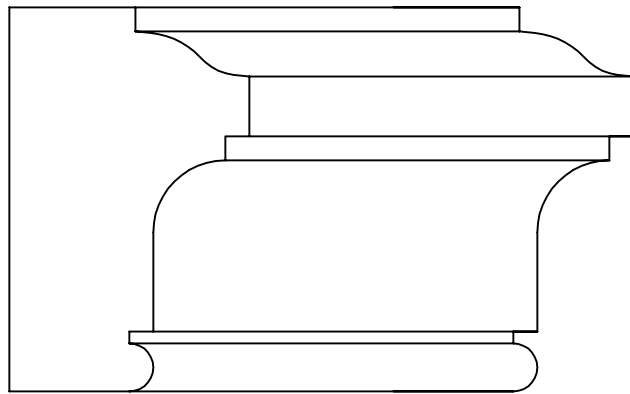

SAW MOULDING (845)-336-8090		
Full scale	Approved:	Drawn by GS
Date		Revised
SAW 6634		Drawing no. A-1